



Power Electronic Measurements

LFR: flexible, clip-around current probe for use in power measurements



These technical notes should be read in conjunction with the LFR short-form datasheet.

Power Electronic Measurements Ltd
Nottingham • UK
Tel: +44 (0) 115 946 9657
Fax: +44 (0) 115 946 8515
Email: info@pemuk.com

Contents

1. Basic operation	3
2. What are the advantages of the LFR Rogowski current probes for current sensing in power measurements?	4
3. Frequency response.....	5
3.1 Amplitude response 0.01Hz to 10Hz.....	5
3.2 Phase response 10Hz to 1kHz	5
3.3 Amplitude response above 100kHz for two different coil lengths	6
3.4 Phase response 10kHz to 100kHz	6
4. Accuracy.....	7
4.1 Accuracy with current magnitude – linearity, internally generated noise and dc offset	7
4.2 Positional Accuracy	9
4.3 Rejecting external currents.....	10
4.4 Voltage interference	11

Figures

<i>Figure 1. Basic Operation.....</i>	<i>3</i>
<i>Figure 2. LFR Low frequency (-3dB) bandwidth</i>	<i>5</i>
<i>Figure 3. LFR Phase response 10Hz to 1kHz bandwidth.....</i>	<i>5</i>
<i>Figure 4. A comparison of the amplitude response > 10kHz of LFR 03/3 with a 300mm coil and a 700mm coil. .</i>	<i>6</i>
<i>Figure 5. A comparison of phase response 10k to 100kHz the LFR03/3 with a 300mm coil and a 700mm coil.</i>	<i>6</i>
<i>Figure 6. Linearity of the LFR03/3 with 300mm coil</i>	<i>7</i>
<i>Figure 7. Noise on 10mV/A (600A peak range) LFR03/3</i>	<i>8</i>
<i>Figure 8. Positional accuracy variation</i>	<i>9</i>
<i>Figure 9. Percentage of external current measured by the LFR</i>	<i>10</i>

1. Basic operation

The LFR is an ac current sensor. It comprises of a thin, flexible, clip-around sense coil (a Rogowski coil), which is connected to an electronic integrator housed in a small electronics enclosure.

The voltage induced in a Rogowski coil is proportional to the **rate of change** of current enclosed by the coil-loop. It is therefore necessary to **integrate** the Rogowski coil voltage in order to produce a voltage proportional to the current.

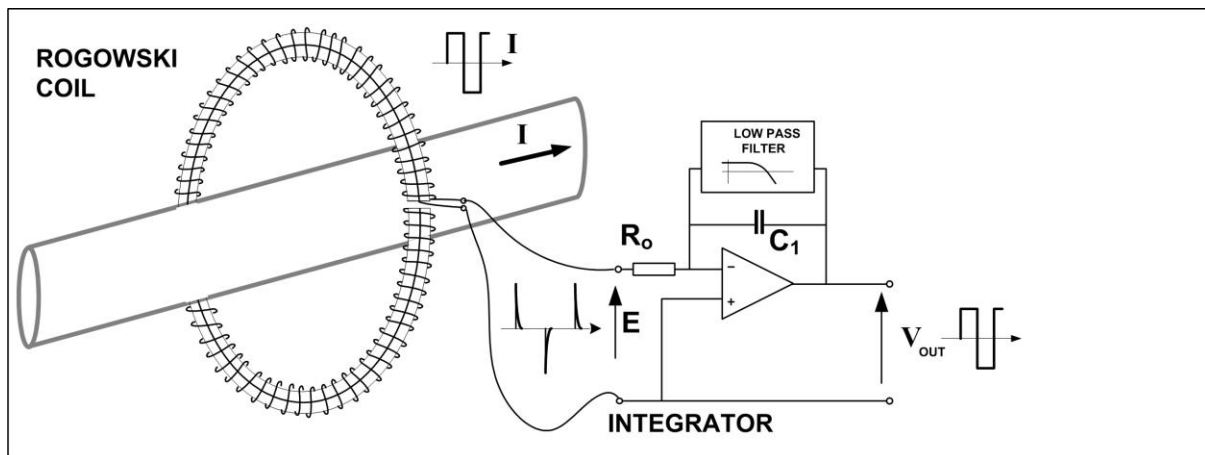

Figure 1. Basic Operation

The coil is uniformly wound with N turns/m on a non-magnetic former of constant cross sectional area A m². If formed into a closed loop then the voltage e induced in the coil is given by the equation:

$$e = \mu_0 N A \frac{di}{dt} = H \frac{di}{dt}$$

where H (Vs/A) is the coil sensitivity and I is the current to be measured passing through the loop.

The loop does not need to be circular and e is independent of the current position in the loop. To reproduce the current waveform as a measurement signal which can be displayed on an oscilloscope or quantified using a DVM, all that is required is a means for accurately integrating the coil voltage, such that:

$$V_{out} = (1/T_i) \int e \cdot dt = R_{sh} \cdot I$$

where $T_i = R_o C_1$ and $R_{sh} = H/T_i$ is the transducer sensitivity in (V/A).

2. What are the advantages of the LFR Rogowski current probes for current sensing in power measurements?

Like a current transformer (CT), the LFR does not measure the direct current component, only the alternating components. However unlike CTs, the LFR sensors:

- ✓ **...have a very wide-bandwidth**
- ✓ **...have a small, known, phase error, for power measurements at 45/65Hz and above.** Ideal for power measurement or power quality monitoring.
- ✓ **...do not suffer from magnetic saturation so are very linear**
- ✓ **... the size of the Rogowski coil can be chosen independently of the current magnitude.** This is unlike other current transducers which become bulkier as the current magnitude increases. For currents of several kA's or more there is really no better alternative than the Rogowski transducer!
- ✓ **...are very easy to use** - the coil is thin, flexible and easy to insert around a current carrying device.
- ✓ **...can take large current overloads without damage**
- ✓ **...can measure AC signals superimposed on large DC.** The transducer does not measure direct currents - as a result it can measure small AC currents in the presence of a large DC component.
- ✓ **...provide an isolated measurement at ground potential** similar to other current transducers (except co-axial shunts) i.e. there is no direct electrical connection to the main circuit.
- ✓ **...are intrinsically safe devices.** There is no danger of an open circuit secondary.

3. Frequency response

The LFR has a wide-bandwidth and is optimised to give a flat sensitivity (V/A) and small phase error over a very wide range of frequencies.

At low frequencies < 1kHz the phase error of the sensor is determined principally by high stability passive components. Hence any phase error is very predictable.

At higher frequency > 10kHz the phase error is determined by the dynamics of the Rogowski coil, the connecting cable and the electronic integrator which are carefully controlled to provide a predictable frequency response.

Longer Rogowski coils give a larger phase error and have a lower high frequency (-3dB).

3.1 Amplitude response 0.01Hz to 10Hz

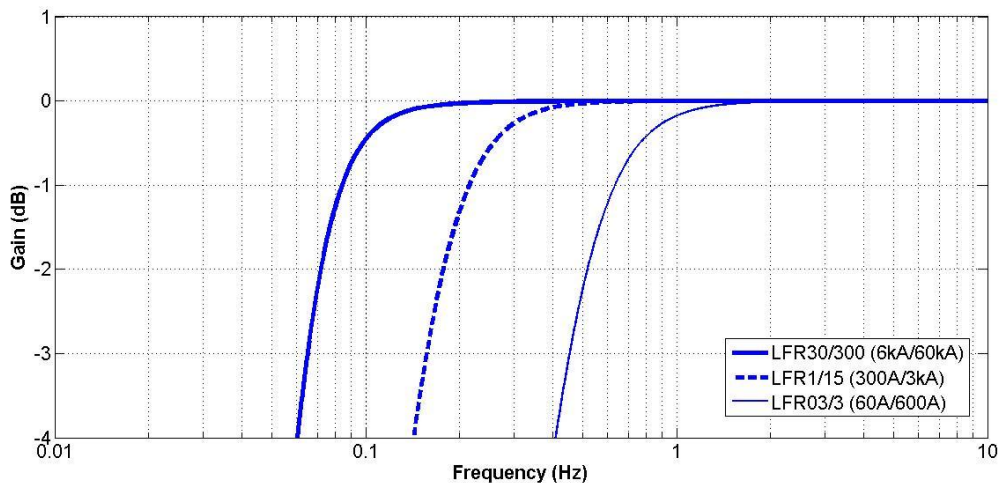

Figure 2. LFR Low frequency (-3dB) bandwidth

3.2 Phase response 10Hz to 1kHz

The phase error is controlled to $\pm 10\%$ of the nominal value shown in the bode plot below.

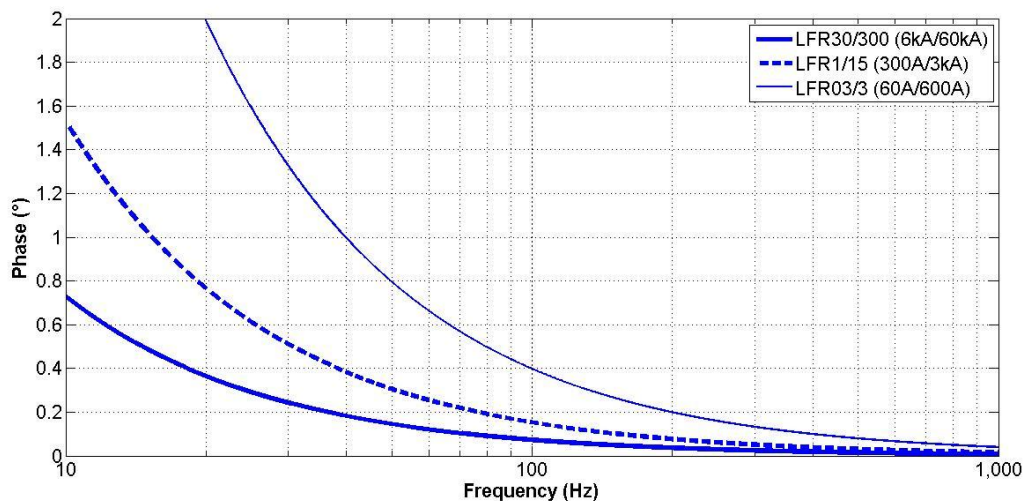

Figure 3. LFR Phase response 10Hz to 1kHz bandwidth

3.3 Amplitude response above 100kHz for two different coil lengths

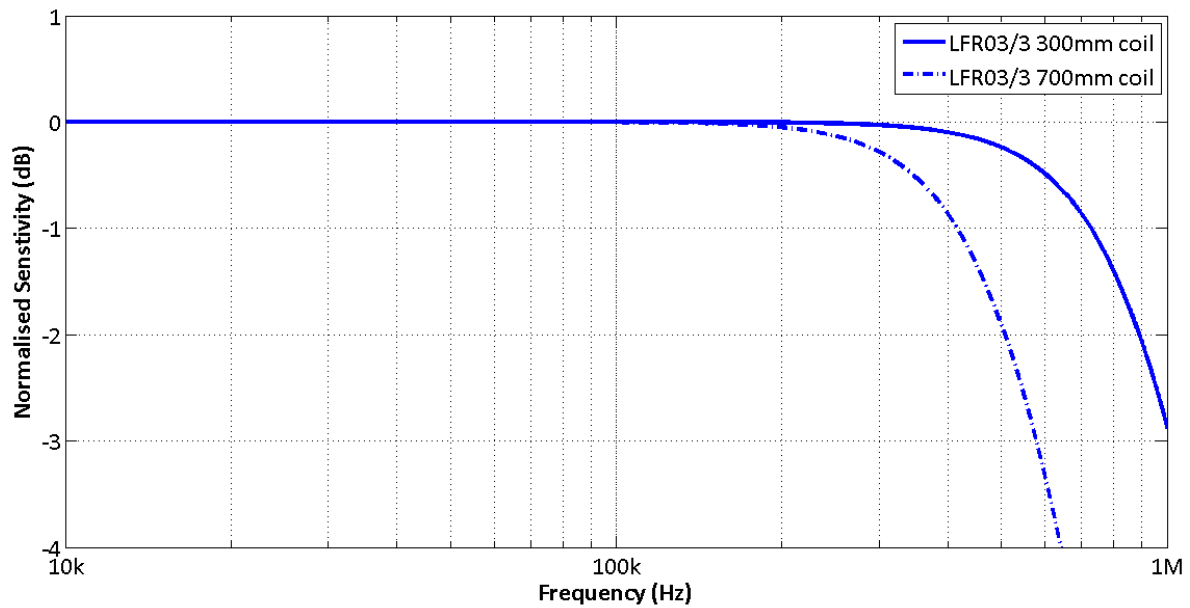

Figure 4. A comparison of the amplitude response > 10kHz of LFR 03/3 with a 300mm coil and a 700mm coil.

3.4 Phase response 10kHz to 100kHz

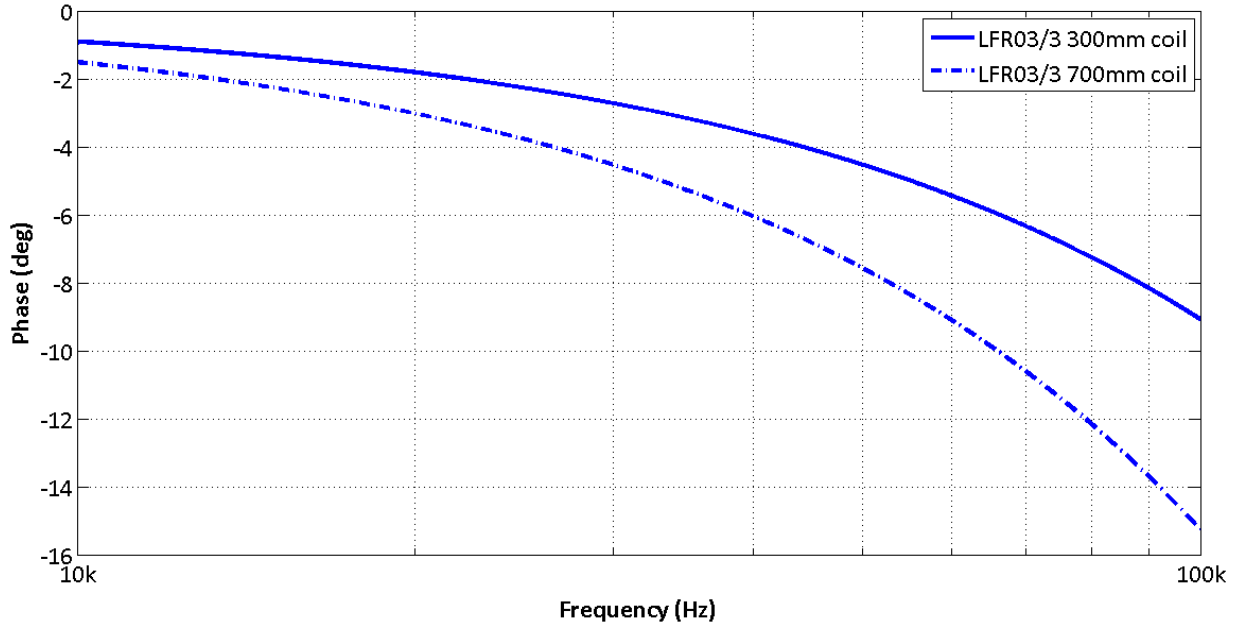

Figure 5. A comparison of phase response 10k to 100kHz the LFR03/3 with a 300mm coil and a 700mm coil.

PEM have an accurate models of the high frequency performance of the LFR for all possible combinations of coil and cable length and can provide a frequency response or phase error calculation as necessary.

4. Accuracy

4.1 Accuracy with current magnitude – linearity and internally generated noise

Linearity error is the difference ΔI between the true current value, I , and the measured value V_{out}/R_{SH} (where R_{SH} is the sensitivity in V/A). For a fixed frequency and fixed current position the linearity error will vary with the current magnitude over the rated current of the Rogowski current probe.

Rogowski current transducers contain no magnetic materials. Therefore there are no saturation or non-linear effects associated with the magnitude of the current. Additionally the integrator gain is set by highly stable low drift passive components which ensure excellent linearity.

As an example, linearity was measured by varying a sinusoidal current source such that the LFR03/3 measured from peak current to around 5% of full scale and the results are tabulated in Figure 6. below.

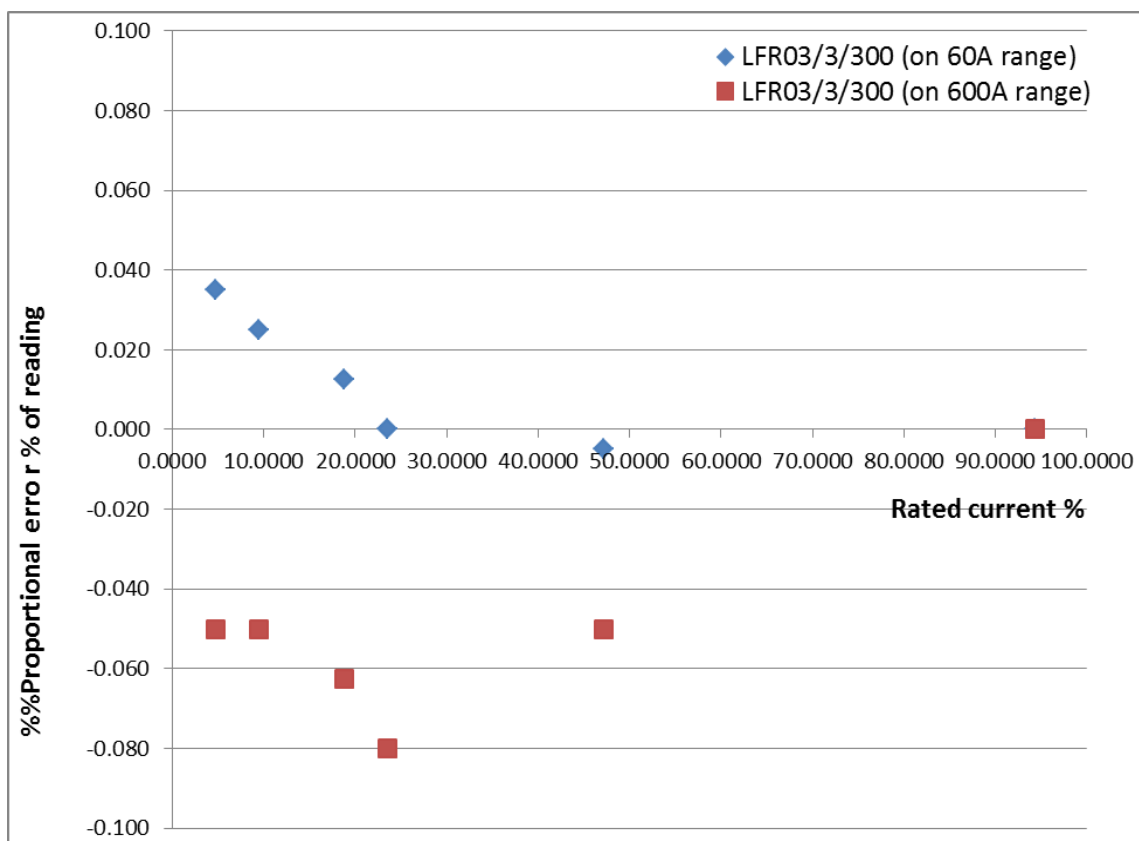

Figure 6. Linearity of the LFR03/3 with 300mm coil

The comparative measurement device is a current transformer, having a traceable UKAS calibration certificate across the current range. The measurements are compared on a Keithley model 2000 DMM, having a traceable UKAS calibration certificate. The number of ampere turns through the Rogowski coil and through the current transformer is arranged such that the DMM is used only to compare two substantially equal voltages. Thus the accuracy of the DMM is not relevant. Taking into account the specified uncertainty and the typical calibration drift over one year, the estimated uncertainty for the calibrated sensitivity (V/A) of the current transformer is $\pm 0.1\%$.

From the results in the scatter graph the linearity was found to be better than $\pm 0.05\%$ of full scale quoted on the shortform datasheets. The linearity is almost certainly better than this since the accuracy of measuring the current is of the same order as the differences.

The factors that can affect the linearity of the LFR 03/3 include:

Low Frequency Noise

The integrator op-amp generates random low frequency noise (often called $1/f$ noise). This noise is distributed around the low frequency bandwidth f_L where the integrator gain is at a maximum. The magnitude of this noise is proportional to $1/f_L H$ where H is the coil sensitivity in (Vs/A).

An example of low frequency noise is shown below.

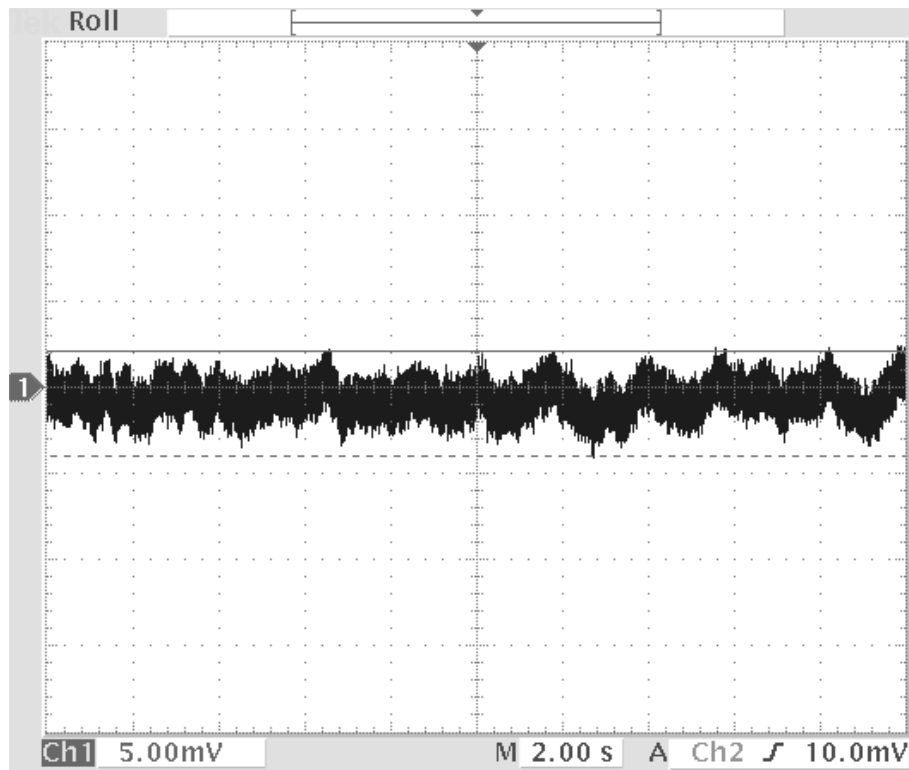

Figure 7. Noise on 10mV/A (600A peak range) LFR03/3
Peak to peak value is 6.1mV corresponding to an rms value of 1.0mV

DC Offset

The output from the electronic integrator is decoupled into a buffer amplifier. The mean output should ideally be zero but in practice there is a very small DC offset.

The maximum DC offset at the output of the LFR is $\pm 2.5\text{mV}$

4.2 Positional Accuracy

Due to small variations in the winding density and coil cross sectional area the transducer output varies slightly depending on the position of the current in the Rogowski coil and also the size of the current conductor relative to the coil.

PEM have developed an accurate method of manufacturing Rogowski coils which keeps this positional variation to a minimum.

To quantify this variation tests were performed with two different coil circumferences, 300mm and 700mm, and two different conductor diameters 10mm and 50mm, the results are shown in Figure 8 **Error! Reference source not found.**

Where the Tables mention '700mm (x2)' the Rogowski coil was wrapped twice around the conductor.

The LFR is calibrated with the conductor central in the coil, position 1, to an accuracy of $\pm 0.3\%$. The values listed in the tables are an additional uncertainty due to the conductor position. The results are all worst case of the total batch of six coils tested.

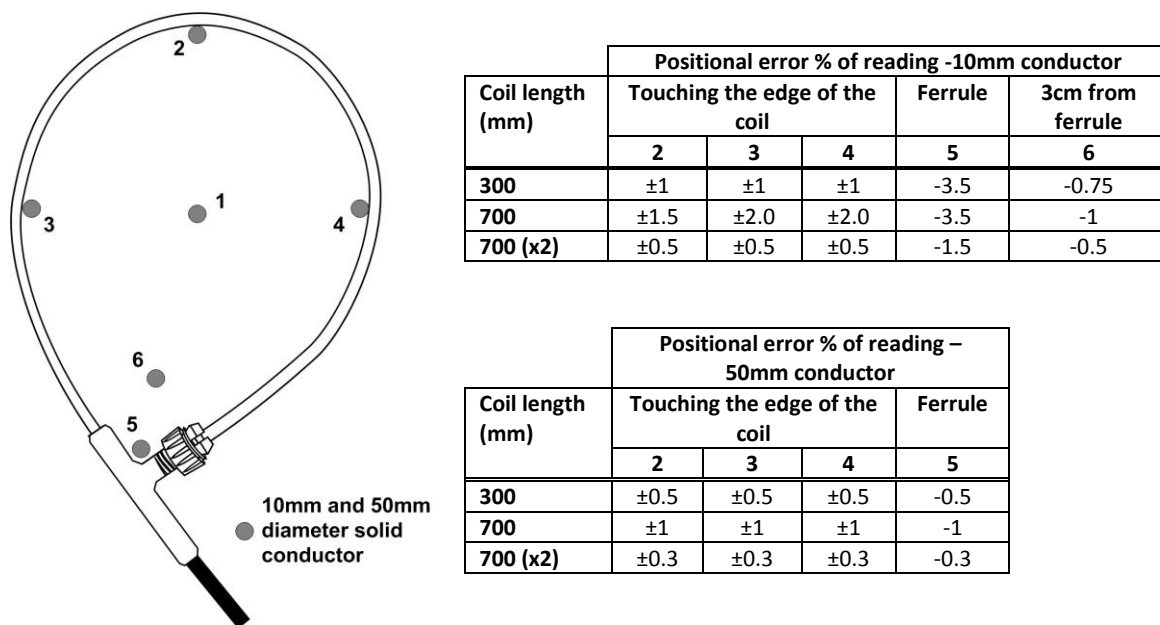

Figure 8. Positional accuracy variation

The results can be summarised as follows:

- For both coil lengths the variation of accuracy with conductor position improves as the size of the conductor increases relative to the Rogowski coil area.
- The positional variation is always at its worst where the coil clips together, every effort must be made to keep the conductor away from this area.
- Wrapping the Rogowski coil twice around a given conductor greatly improves the positional variation (i.e. comparing the 300mm and the 700mm (x2) results). However it should be noted that wrapping the coil twice around the conductor also halves the rated current and doubles the sensitivity (V/A).

From these results we derive the typical accuracy of $\pm 1\%$ of reading quoted on the short-form datasheet.

4.3 Rejecting external currents

Currents external to the Rogowski coil can cause measurement interference.

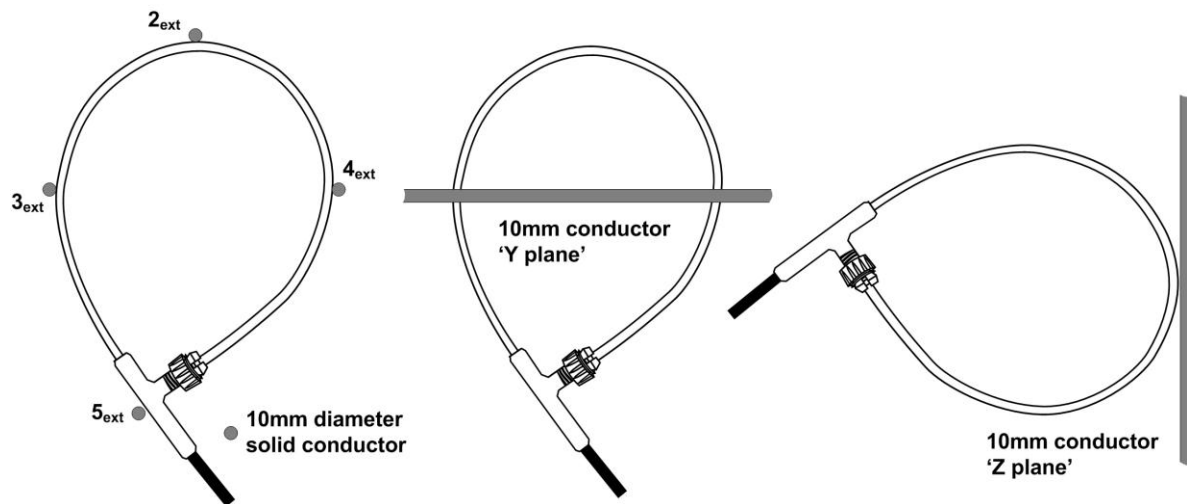

Coil length (mm)	Positional error % of reading					
	Touching the edge of the coil			Ferrule	Touching the coil	
	2 _{ext}	3 _{ext}	4 _{ext}	5 _{ext}	'Y-plane'	'Z-Plane'
700	±1.5	±2	±2	-3.5	±1	±1

Figure 9. Percentage of external current measured by the LFR

Figure 9. shows similar conductor positions to those shown in Figure 8, adjacent to the coil edge but this time outside the Rogowski loop. All the tests in Figure 9. were carried out using the 10mm conductor and the 700mm coil and there is a very similar error of reading to those specified in equivalent positions in **Error! Reference source not found.** This is worst case; a 10mm conductor represents only 2% of the Rogowski coil area (point source of current).

The LFR will often be installed in areas where conductors external to the Rogowski coil are in alternate planes to those shown in Figure 9. The LFR coil has a cancellation loop which greatly reduces its susceptibility to these currents keeping the external pick-up to typically ±1% in the 'Y and Z -plane' positions shown.

If the external current (outside the coil loop) is much greater than the current being measured (inside the coil loop) then the error may be significant. This is particularly relevant if the external current is flowing in a nearby multi-turn coil.

4.4 Voltage interference

Rogowski coils are susceptible to voltage pick-up through capacitive coupling onto the Rogowski coil winding. For a given Rogowski coil this pick-up gets worse as the rated current of the unit decreases and the sensitivity (V/A) increases. PEM has published significant research into resolving this problem. The LFR range of Rogowski coils has been optimised to attenuate any voltage interference.

If the voltage close to the coil is subject to high rates of change (e.g. several 100V/ μ s or high frequency oscillations in the MHz range) then a larger interference can occur.

As a check for the effect of external voltages or currents the user should place the Rogowski coil in approximately the same position as used for measuring the desired current, but not looped around the desired current. Ideally there should be no measured signal. If there is interference then the same interference will be superimposed on the current waveform when it is measured and this can be taken into account when interpreting the measurement.